

Sports

Vocabulary





What are these people doing?
 What type of athlete are they?

Sports

- volleyball
- hockey
- surfing
- swimming
- skiing
- golf
- playing basketball
- playing tennis
- playing cricket
- playing rugby
- playing football
- figure skating









Athletes

- ~~volleyball player~~
- figure skater
- football player
- basketball player
- rugby player
- tennis player
- hockey player
- cricket player
- surfer
- golfer
- skier
- swimmer

#	Picture	Sentences
1		<p><i>She is playing volleyball.</i></p> <p><i>She is a volleyball player.</i></p>
2		<p>_____</p> <p>_____</p>
3		<p>_____</p> <p>_____</p>
4		<p>_____</p> <p>_____</p>



Vocabulary cont.

#	Picture	Sentences
5		_____ _____
6		_____ _____
7		Dani _____ _____
8		Juan _____ _____
9		My aunt _____ _____
10		Grandad _____ _____
11		My sister _____ _____
12		I _____ _____

Expressions

A. Verbs

Write the sports under the correct verbs.

Sports	
• swimming	• judo
• rugby	• football
• cricket	• golf
• hockey	• skiing
• yoga	• gymnastics

Play (team sports)	Do (individual sports)	Go (-ing sports)

Expressions cont.

B. Talking about Sports

Listen and repeat these sentences.

1. **My** favourite sport is **golf**.
2. I like **playing golf**.
3. I am **golfing**.
4. I am a **golfer**.
5. I **golf** every **Tuesday**.
6. **Golf** is a **difficult** sport.
7. I **golf** at a **golf course**.
8. I **play golf** with **my friends**.
9. I need new **golf clubs**.
10. I like watching **golf** on TV.

C. Practice

Find a partner. Read the sentences in Part B out loud, but change the words in **bold**. Take turns talking about different sports and people.

Example

1. My gran's favourite sport is swimming.
 2. Gran likes going swimming.
 3. Gran is swimming.
 4. Gran is a swimmer.
 5. Gran swims every weekend.
- etc.

Questions & Answers



Read the questions and answers about sports.

On the next two pages, practise asking and answering questions using complete sentences. Use the words in parentheses to help you.

#	Picture	Questions & Answers
1	 <p data-bbox="289 1081 350 1129">Jill</p>	<p data-bbox="505 682 954 724">What is Jill doing? (swimming)</p> <p data-bbox="505 751 1490 793"><u>She is swimming.</u></p> <p data-bbox="505 829 971 871">What is Jill wearing? (swimsuit)</p> <p data-bbox="505 898 1490 940"><u>She is wearing a swimsuit.</u></p> <p data-bbox="505 976 1091 1018">Is it a one-piece or a bikini? (one-piece)</p> <p data-bbox="505 1045 1490 1087"><u>It is a one-piece.</u></p> <p data-bbox="505 1123 1127 1165">What is Jill wearing on her eyes? (goggles)</p> <p data-bbox="505 1192 1490 1234"><u>She is wearing goggles.</u></p>





Questions & Answers cont.

#	Picture	Questions & Answers
2	 <p>Dani</p>	<p>What is Dani doing? (playing tennis)</p> <hr/> <p>What equipment is Dani using? (tennis racket and ball)</p> <hr/> <p>Does Dani like playing tennis? (yes)</p> <hr/> <p>Where does Dani play tennis? (tennis court)</p> <hr/>
3	 <p>You</p>	<p>What is your favourite sport? (cricket)</p> <hr/> <p>Do you like to bat or bowl? (bat)</p> <hr/> <p>What other equipment do you use? (pads and ball)</p> <hr/> <p>Where do you play cricket? (park behind house)</p> <hr/>

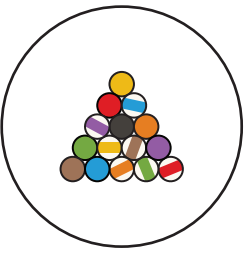

Questions & Answers cont.

#	Picture	Questions & Answers
4	 <p>Ricardo & Tessa</p>	<p>What are Ricardo and Tessa doing? (playing pool)</p> <hr/> <p>Where are they playing? (pool hall)</p> <hr/> <p>Are they good at playing pool? (Tessa yes, Ricardo no)</p> <hr/> <p>What is the stick called? (pool cue)</p> <hr/>
5	 <p>Lena</p>	<hr/> <p>She is skating.</p> <hr/> <p>She is wearing figure skates.</p> <hr/> <p>No, she doesn't play ice hockey.</p> <hr/> <p>She skates at an ice rink near her school.</p>

Pair Work (Student A)

A. Complete the Chart

Find out the missing information by asking your partner.

#	Name	Sport	Location	Level	Equipment Needed
1	Raj	volleyball		junior	
2	Brian		ice rink	beginner	
3	Bailey	pool		highly skilled	
4	Kya		park		a new batting helmet
5	Junko	surfing	ocean		
6	Monica	skiing		intermediate	
7	Leo	swimming		Level 4	
8	Sheridan		basketball court		new basketball shoes
9	Emah		half pipe	professional	
10	Lucy		tennis court		more tennis balls

Pair Work (Student B)

A. Complete the Chart

Find out the missing information by asking your partner.

#	Name	Sport	Location	Level	Equipment Needed
1	Raj		volleyball court		new shorts
2	Brian	ice hockey			bigger skates
3	Bailey		pool hall		new pool cue
4	Kya	cricket		junior	
5	Junko			advanced	swimsuit
6	Monica		mountains		ski poles
7	Leo		swimming pool		new goggles
8	Sheridan	basketball		B Team	
9	Emah	skateboarding			elbow pads
10	Lucy	tennis		intermediate	

Pair Work cont.

B. Writing

Work together to make sentences using the information from Part A.

Class Survey

What do you like to do for fun and exercise? Fill in your answers.
Then walk around the class and find out what your classmates like to do.

Name	Sport	Place	When	Why
Me				

Picture Dictionary

What sport, location, or piece of equipment do you see in the picture?
Add some more pictures of your own.

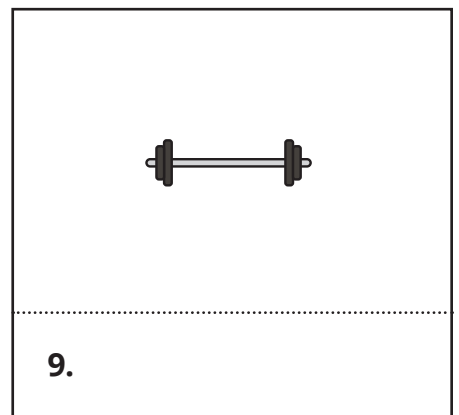
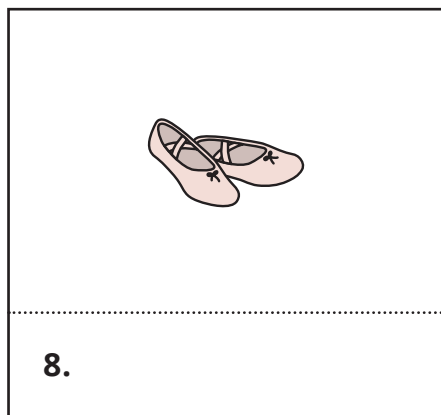
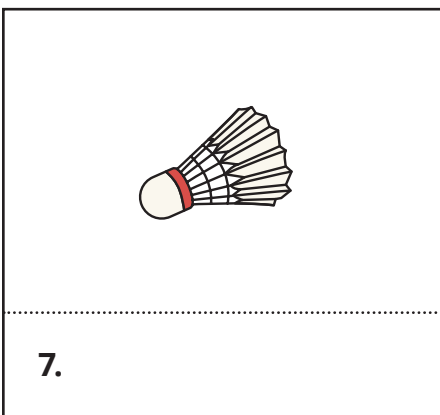
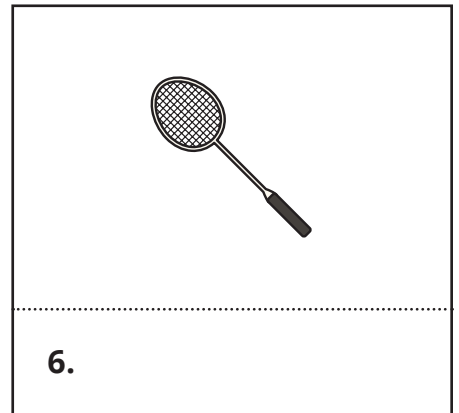
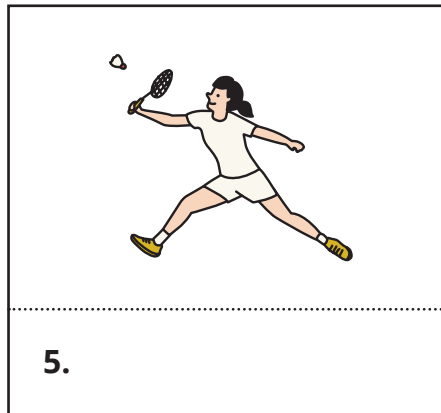
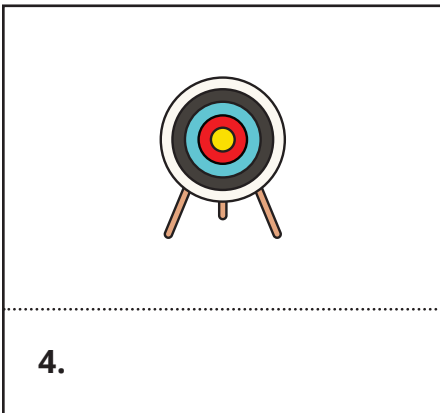
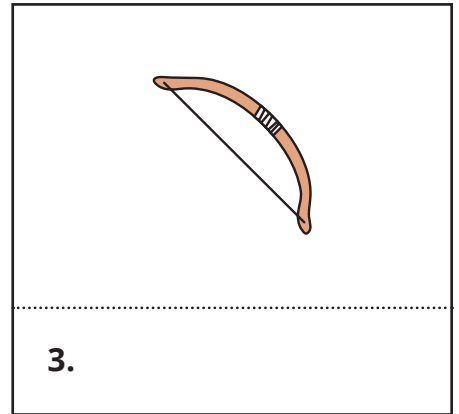
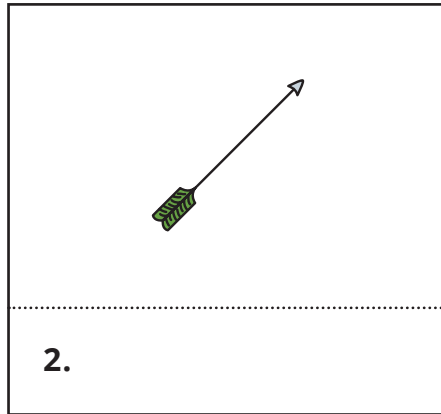
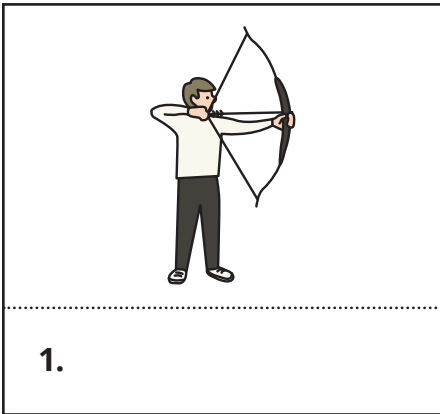

Picture Dictionary cont.

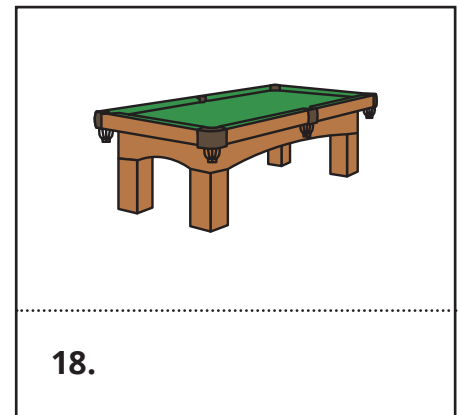
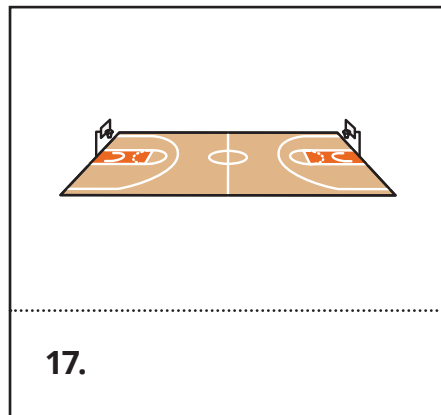
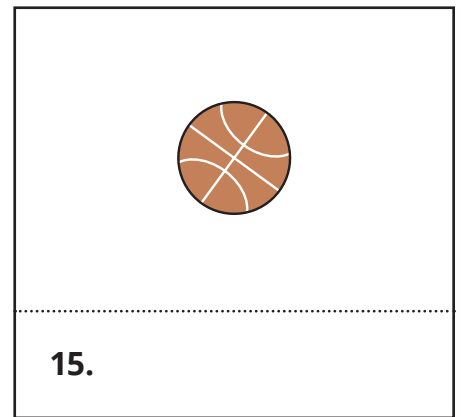
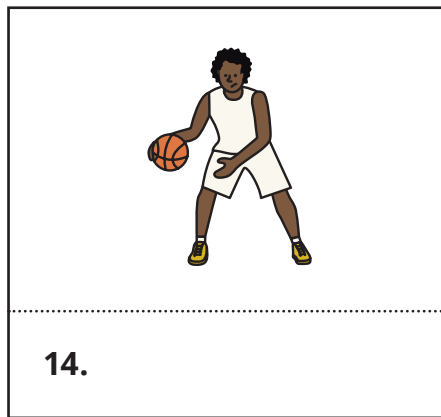
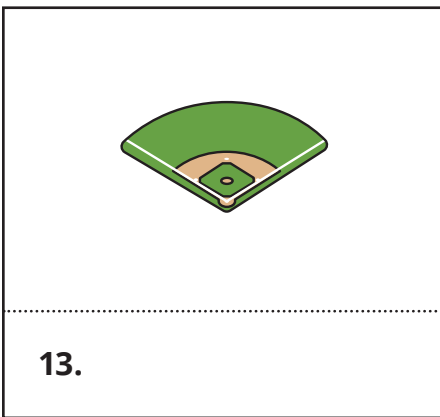
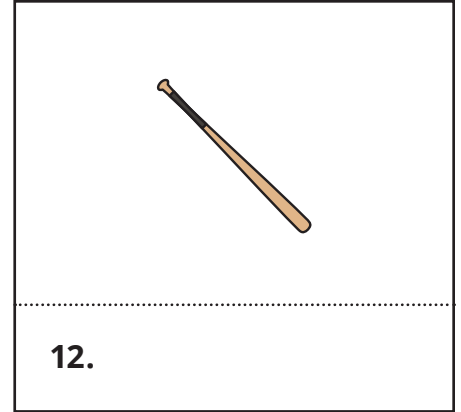
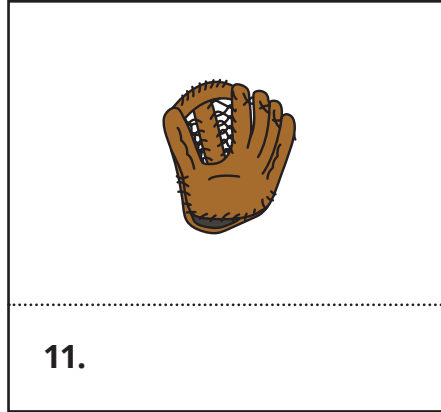
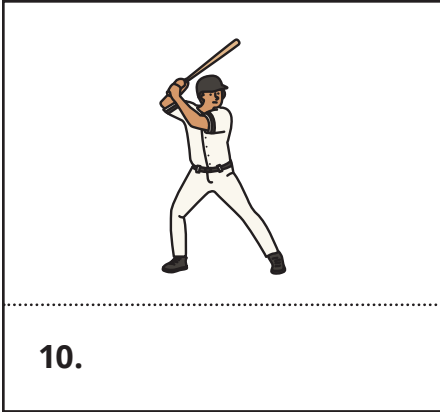

Picture Dictionary cont.



19.



20.



21.



22.



23.



24.



25.

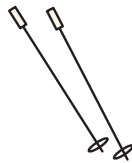

26.



27.



Picture Dictionary cont.

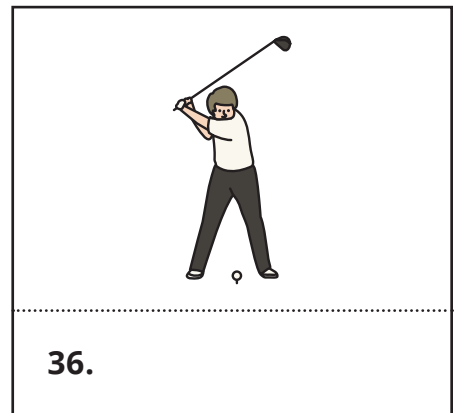
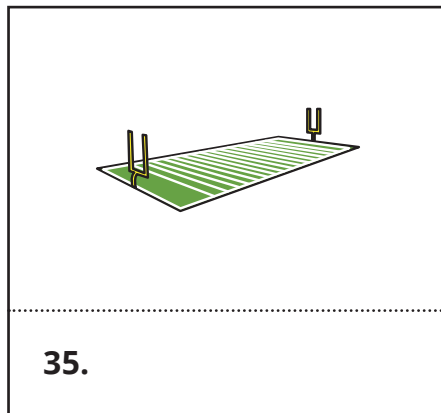
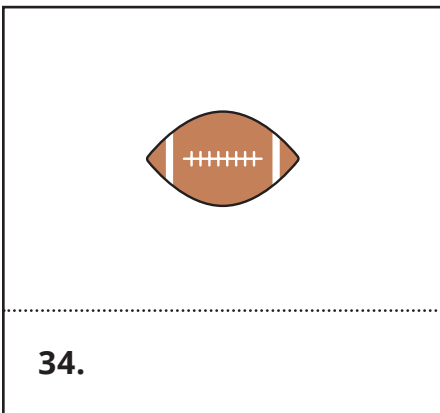
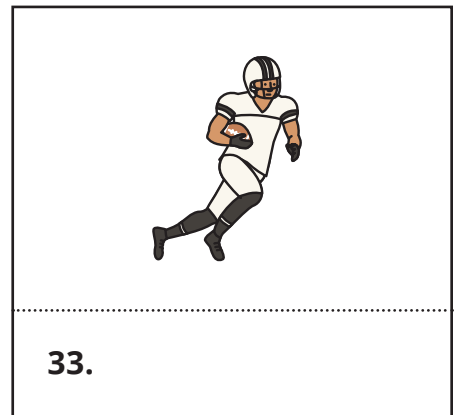
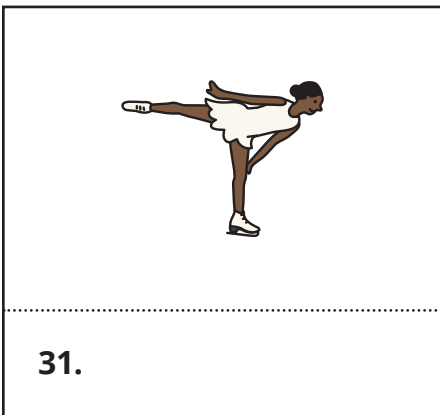
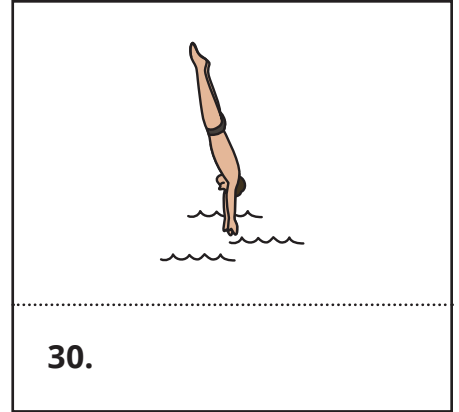
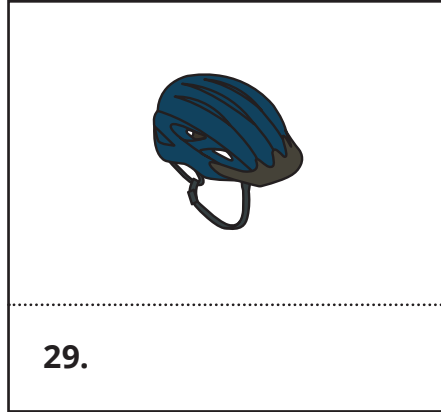
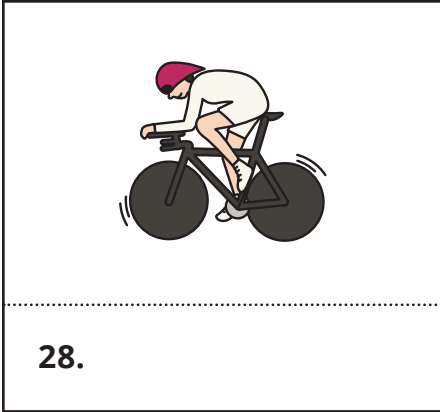

Picture Dictionary cont.

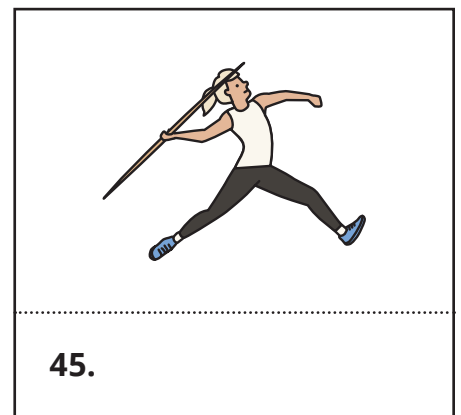
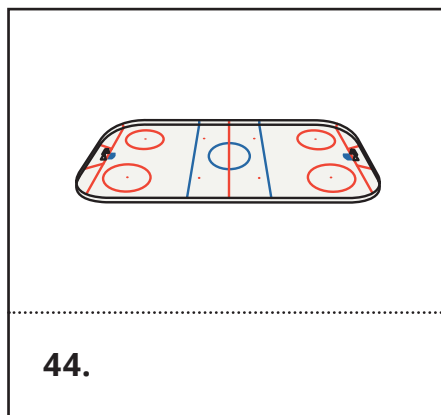
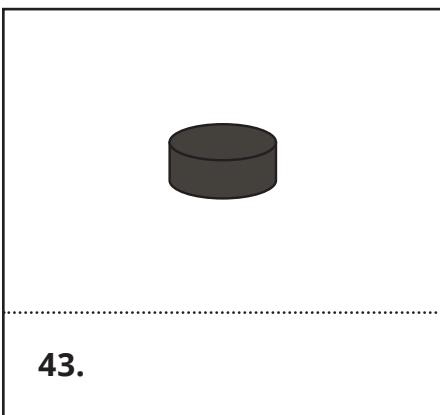
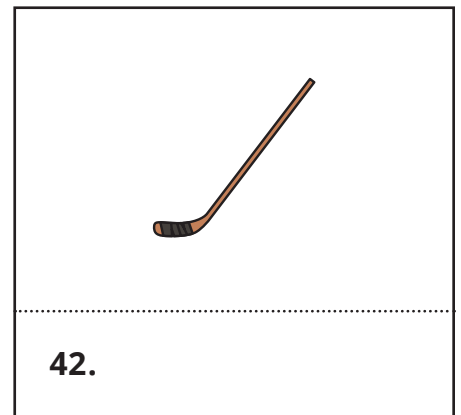
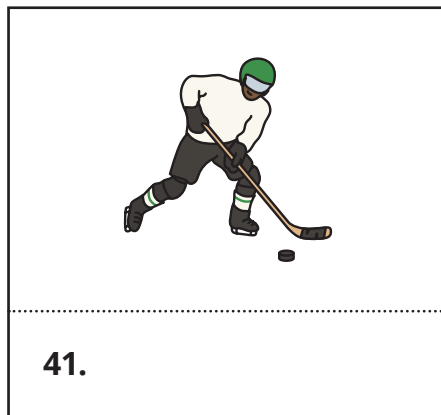
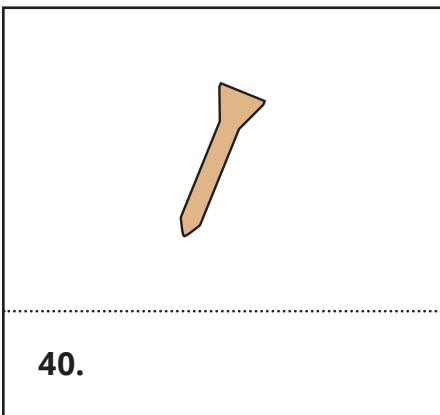
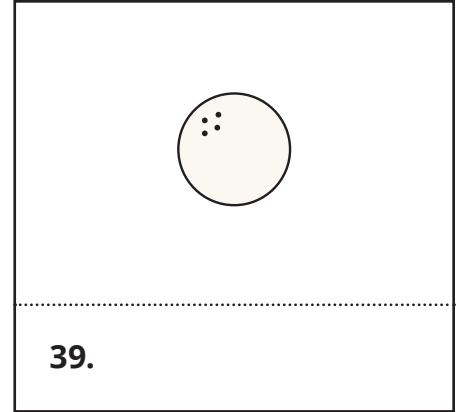
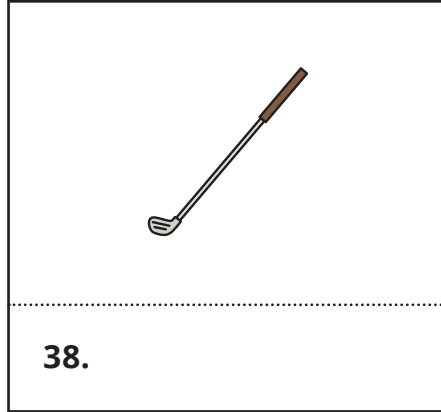
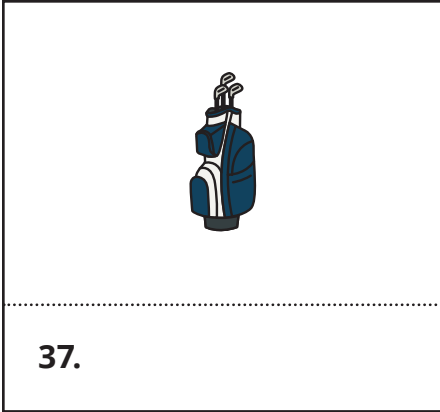

Picture Dictionary cont.

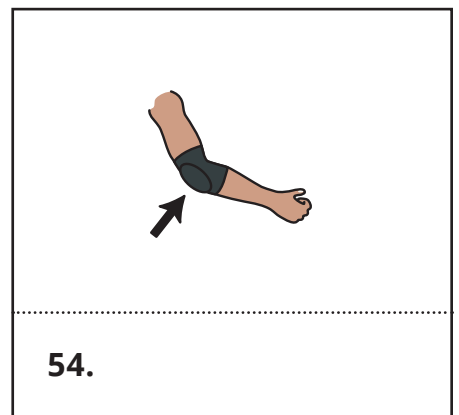
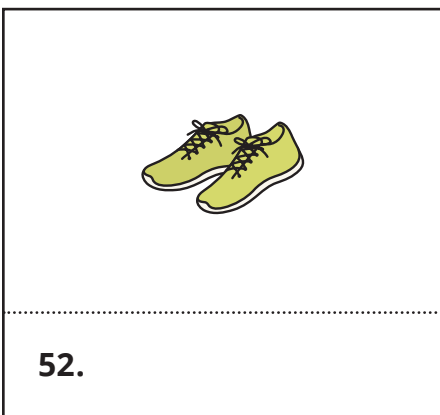
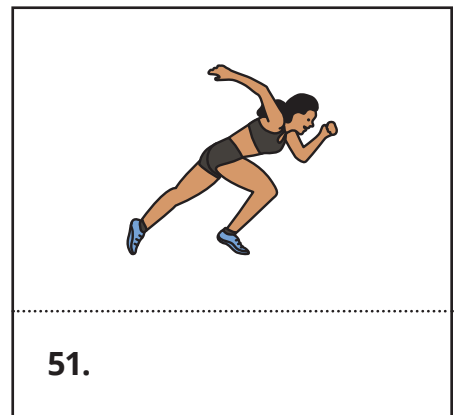
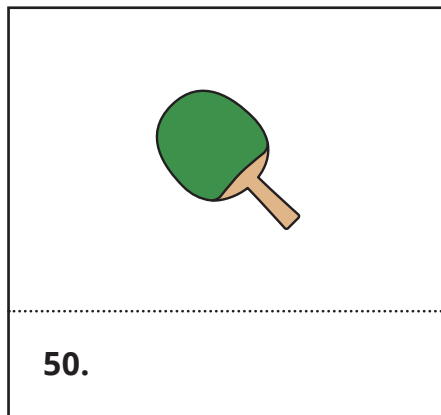
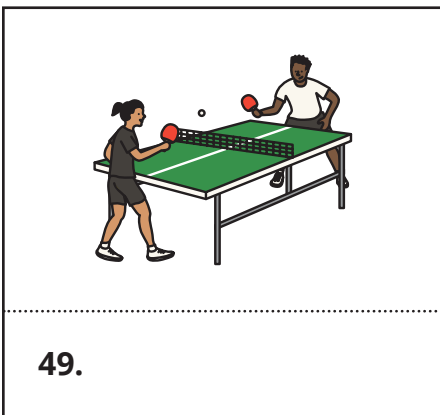
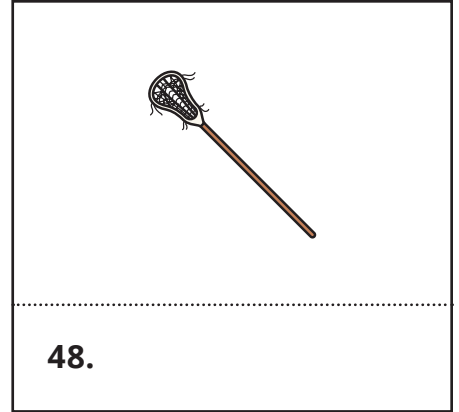
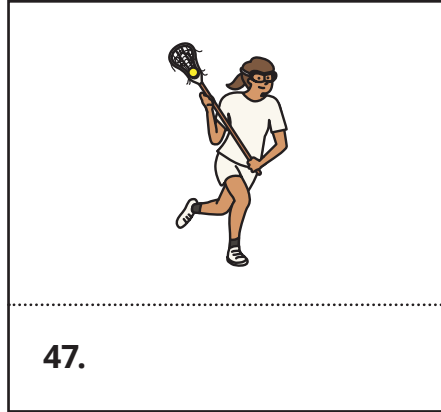
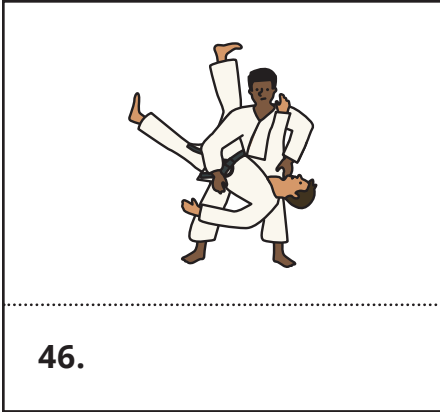

Picture Dictionary cont.

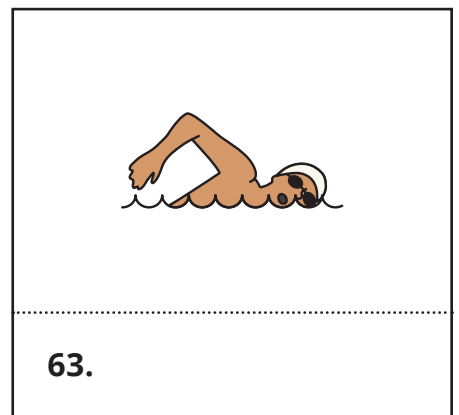
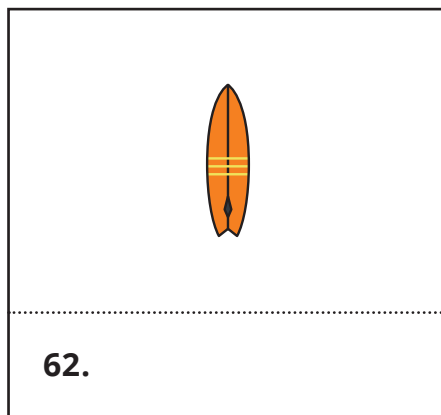
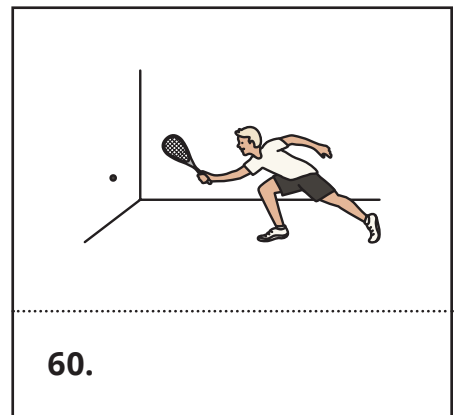
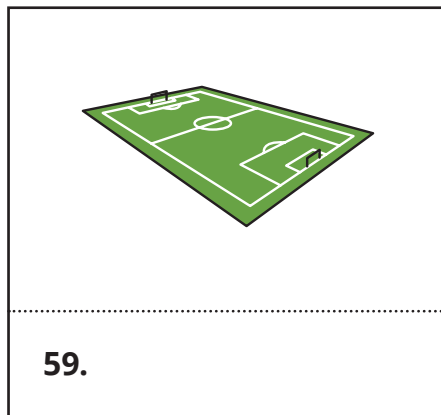
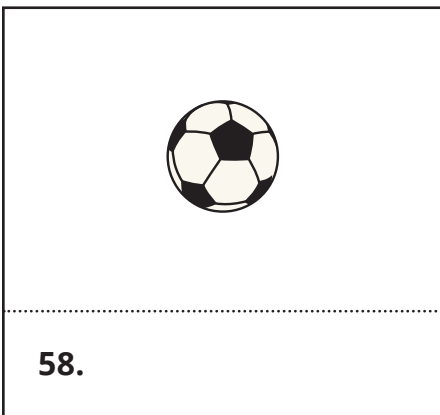
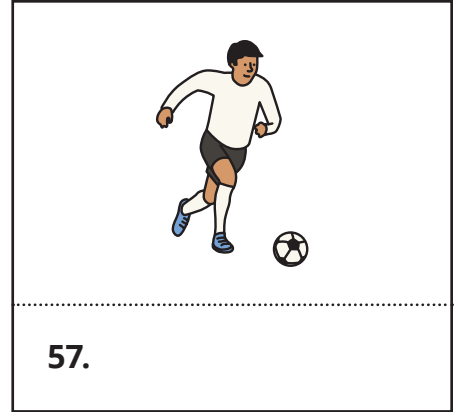
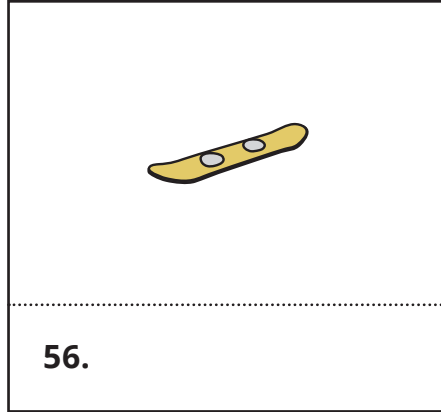
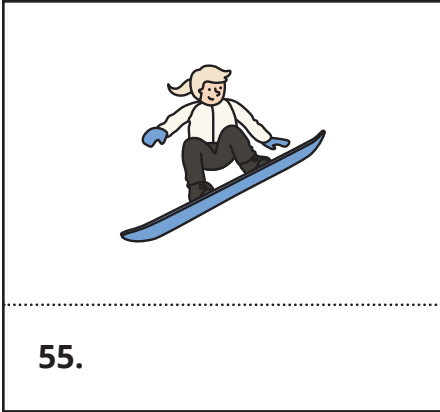

Picture Dictionary cont.

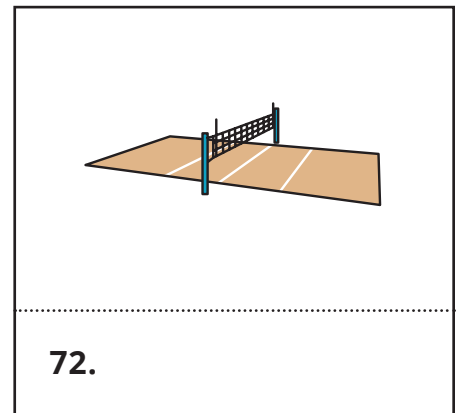
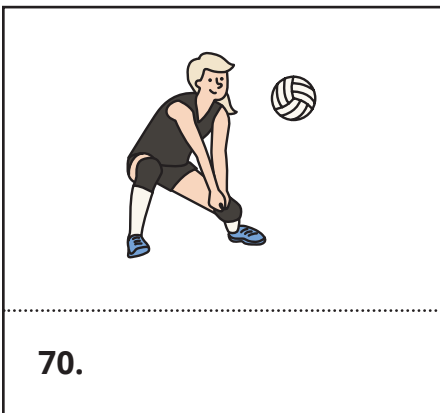
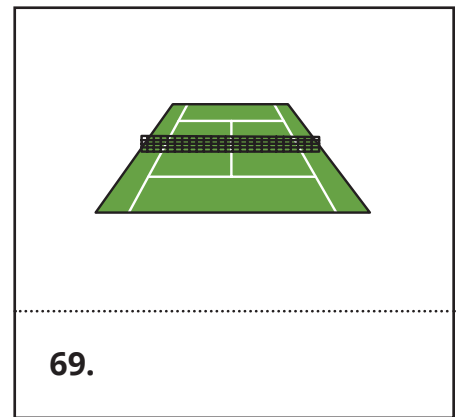
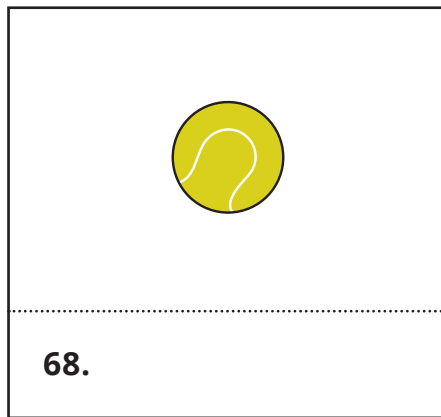
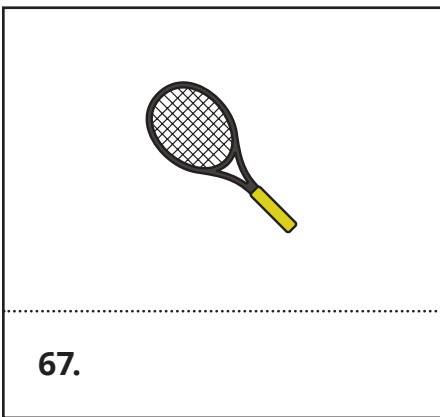
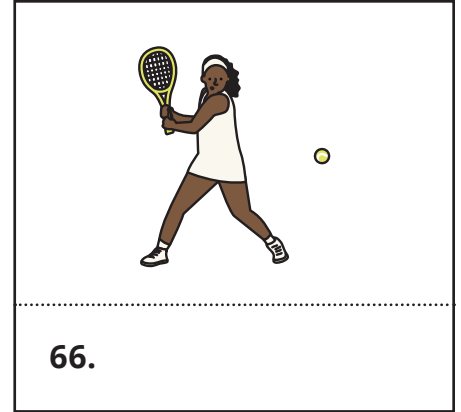
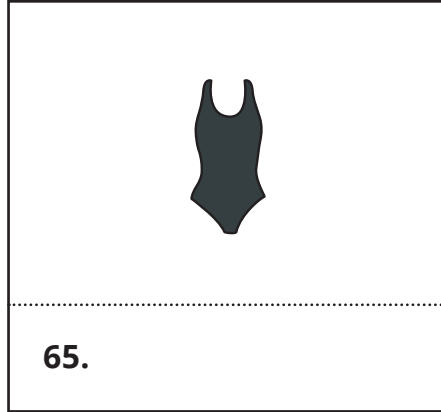
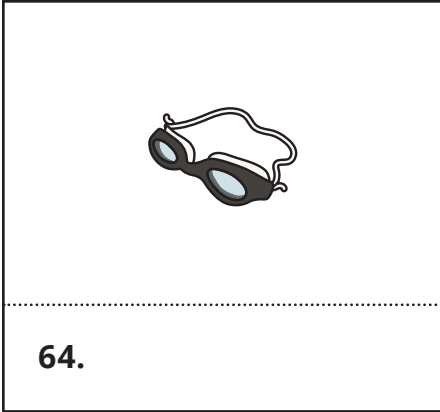

Picture Dictionary cont.



73.



74.



75.

Assessment

Student / Group: _____

Date	Level	Theme	Skills
		Sports	<input type="checkbox"/> Speaking <input type="checkbox"/> Listening <input type="checkbox"/> Reading <input type="checkbox"/> Writing

Criteria	Achieved 	Achieved with Help 	Needs Improvement 
identifies sports, athletes, and equipment			
uses the verbs <i>play</i> , <i>go</i> , and <i>do</i> with sports and athletes			
uses the verb <i>need</i> with sporting equipment			
asks questions about sports			
answers questions about sports			



Notes

Self-Assessment

SPORTS

Add ticks (✓) to show what you've learned in this lesson.

Name: _____ Date: _____

Can I...	Yes (very well) 	Yes (with help) 	Not yet 
say and write words for sports, athletes, and sports equipment?			
describe what athletes are doing?			
use the verbs <i>play</i> , <i>do</i> , and <i>go</i> with sports?			
use the verb <i>need</i> with sports equipment?			
talk about favourite sports?			

My Notes