

# Transportation

## Vocabulary

What form of transportation do you see?



Which verb or modifier fits with each example?

### Transportation

- ~~airplane~~
- bus
- police car
- wheelchair
- submarines
- ferry
- train
- subway
- boat
- stroller
- helicopter
- bicycle









### Verbs & Modifiers

- ~~rescues~~
- rode
- missed
- underwater
- electric
- floats
- ~~fly~~
- underground
- is driving
- pushed
- take
- aboard

#	Picture	Sentences
1		I see an <u>airplane</u> . You <u>fly</u> in an airplane.
2		This is my baby's _____ . I _____ it home.
3		Jon has a _____ . He _____ it home.

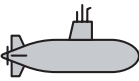

# Vocabulary cont.

#	Picture	Sentences
4		They are on a _____ . It _____ .
5		I see a _____ . It _____ <i>rescues</i> _____ people.
6		This is my _____ . I _____ it to work.
7		That is a _____ . The officer _____ very fast.
8		Let's take the _____ . It runs _____ .
9		Emma is in a _____ . It is _____ .
10		There goes my _____ . I _____ it!
11		I like _____ . They travel _____ .
12		We took the _____ . Our car was _____ too.

# Expressions

## A. Patterns

Look at the four common sentence patterns below.  
Then listen and repeat these sentences about transportation.

### 1. subject + verb + form of transportation

- I take a bus.
- He rides his bike.
- She takes the subway.
- They drive a car.

### 2. subject + Be + -ing verb

- We are flying.
- He is driving.
- You are taking the bus.
- I am taking the train.

### 3. subject + go + by + form of transportation

- I go by train.
- She goes by car.
- We're going by boat.
- They're going by taxi.

### 4. subject + go + on foot (walking)

- They go on foot.
- She goes on foot.
- We went on foot.

## B. Questions & Answers

Read these questions and answers out loud with a partner.

- Q: How are you getting there?  
A: We're going by bus.
- Q: Are you driving?  
A: No, we're walking.
- Q: What's the quickest way to get there?  
A: Take the train.
- Q: How long does it take to get there?  
A: Five hours by plane.
- Q: Do you usually take a taxi?  
A: No, I usually get a ride with a friend.
- Q: How is public transit here?  
A: It's very reliable.

# Questions & Answers

Read the questions and answers about transportation.  
On the next two pages, practise asking and answering questions using complete sentences. Use the words in parentheses to help you.

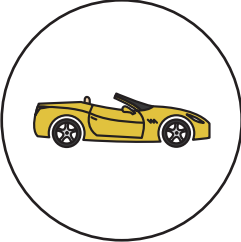
#	Picture	Questions & Answers
1	 <b>Ellen</b>	<p>What kind of car did Ellen buy? (<b>convertible</b>)</p> <p><i>She bought a convertible.</i></p> <hr/> <p>What colour is Ellen's new car? (<b>yellow</b>)</p> <p><i>It's yellow.</i></p> <hr/> <p>Did Ellen put the top up today? (<b>no</b>)</p> <p><i>No, she didn't.</i></p> <hr/> <p>How much did the convertible cost? (<b>\$30,000</b>)</p> <p><i>It cost \$30,000.</i></p> <hr/>

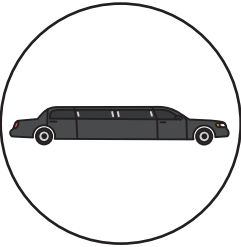
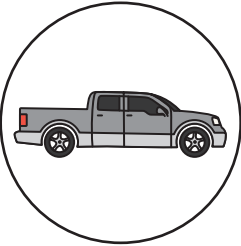

# Questions & Answers cont.

#	Picture	Questions & Answers
2	 <b>Lucy</b>	<p>How is Lucy getting to the wedding? <b>(take a limousine)</b></p> <hr/> <p>How is Lucy's mom getting there? <b>(limo too)</b></p> <hr/> <p>How many people fit in the limo? <b>(ten)</b></p> <hr/> <p>Does that include the driver? <b>(yes)</b></p> <hr/>
3	 <b>Yuka</b>	<p>What kind of vehicle does Yuka need? <b>(pickup truck)</b></p> <hr/> <p>Why does Yuka need a pickup truck? <b>(move some furniture)</b></p> <hr/> <p>Does Yuka know anyone with a pickup truck? <b>(yes, brother)</b></p> <hr/> <p>Is Yuka's brother's pickup truck big enough? <b>(yes, huge)</b></p> <hr/>

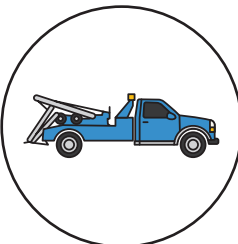
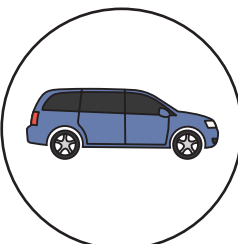

# Questions & Answers cont.

#	Picture	Questions & Answers
4	 <p><b>Tina &amp; Niko</b></p>	<p>What type of vehicle do Tina and Niko need? (<b>tow truck</b>)</p> <hr/> <p>Why do they need a tow truck? (<b>car broke down</b>)</p> <hr/> <p>Did they call a tow truck? (<b>not yet</b>)</p> <hr/> <p>Why didn't they call a tow truck? (<b>cell phone is dead</b>)</p> <hr/>
5	 <p><b>Wesley</b></p>	<hr/> <p>He drives a minivan.</p> <hr/> <p>It has seven seats.</p> <hr/> <p>It is blue.</p> <hr/> <p>He bought it last year.</p>

# Pair Work (Student A)

## A. Complete the Chart

Find out the missing information by asking your partner.

#	Name	Form of Transportation to Work	Place of Work	How Long it Takes to Get to Work	Preferred Mode of Transportation
1	<b>Rico</b>	bicycle		10 minutes	
2	<b>Ramona</b>		university		taking the bus
3	<b>Marta</b>	train		1/2 hour	
4	<b>Kal</b>		grocery store		taking the train
5	<b>Mika</b>	bus		20 minutes	
6	<b>Malaya</b>		government building		flying
7	<b>Chang</b>	walking		5 minutes	
8	<b>Sonya</b>		jewellery shop		driving
9	<b>Abdul</b>	car		1 hour	
10	<b>Jen</b>		clothing store		biking

# Pair Work (Student B)

## A. Complete the Chart

Find out the missing information by asking your partner.

#	Name	Form of Transportation to Work	Place of Work	How Long it Takes to Get to Work	Preferred Mode of Transportation
1	<b>Rico</b>		bank		walking
2	<b>Ramona</b>	motorcycle		1/2 hour	
3	<b>Marta</b>		school		biking
4	<b>Kal</b>	subway		1 hour	
5	<b>Mika</b>		gym		taking the train
6	<b>Malaya</b>	friend's car		15 minutes	
7	<b>Chang</b>		church		jogging
8	<b>Sonya</b>	ferry		1 hour	
9	<b>Abdul</b>		restaurant		flying
10	<b>Jen</b>	minivan		20 minutes	



# Pair Work cont.

## B. Writing

Work together to make sentences using the information from Part A.

---

---

---

---

---

---

---

---

---

---

---

---

---

---

---

---

---

---

---

---

---

---

---

# Class Survey

Find out how your classmates get to school and get around their neighbourhood. What are their favourite forms of transportation?

Classmate	How I Get to School	How I Get Around My Neighbourhood	My Favourite Type of Transportation
Me			

# Picture Dictionary

What form of transportation do you see?  
Add some more pictures of your own.

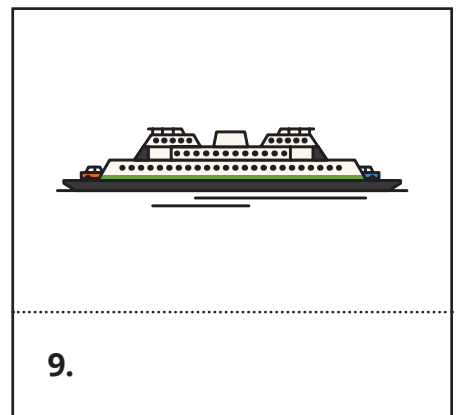
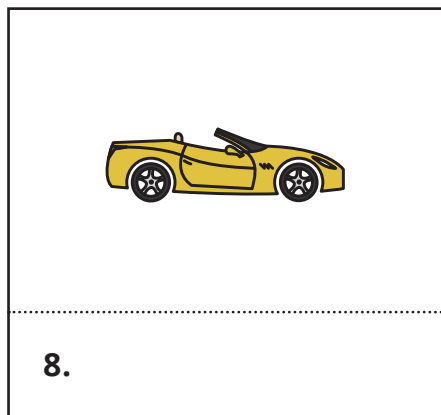
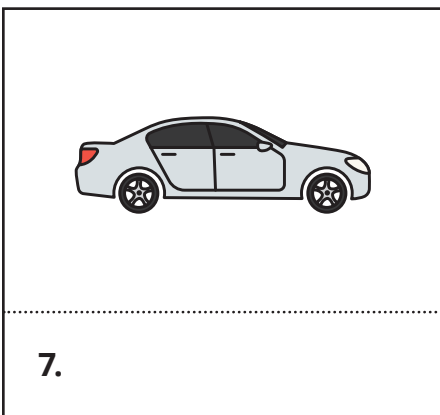
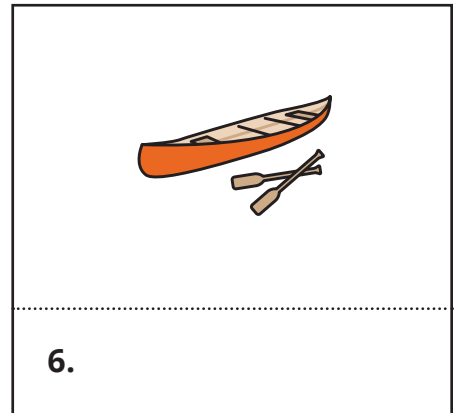
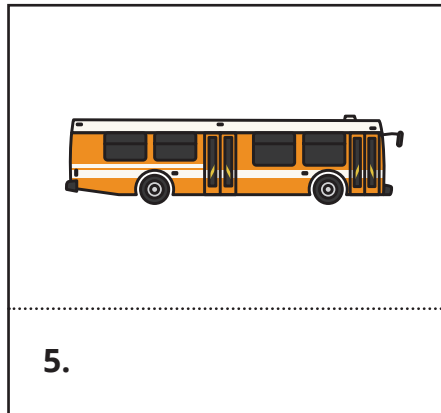
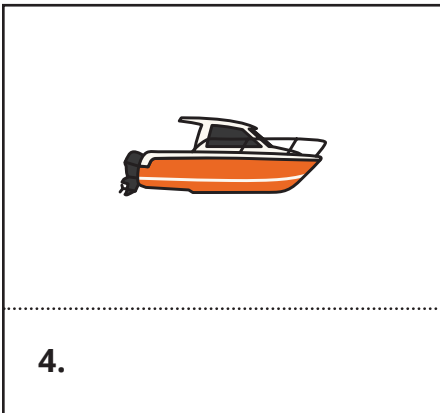
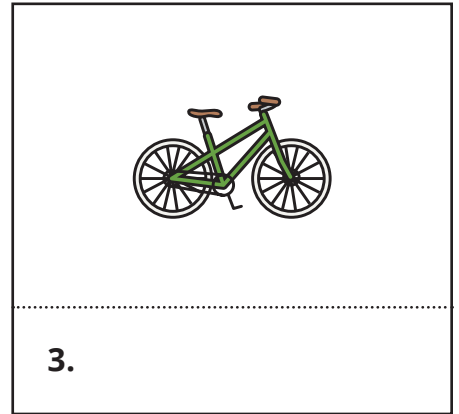
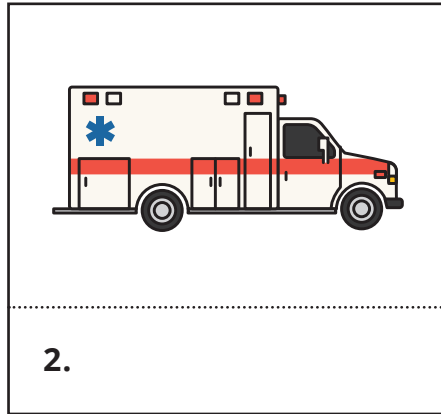
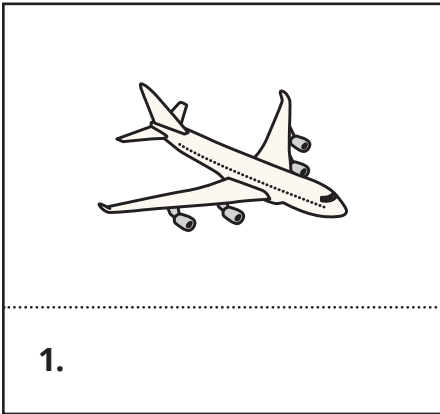

# Picture Dictionary cont.



10.



11.

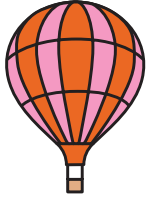

12.



13.



14.

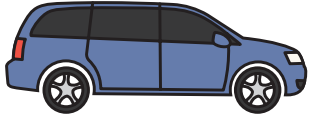

15.



16.

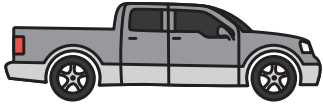

17.



18.



# Picture Dictionary cont.



19.



20.



21.



22.

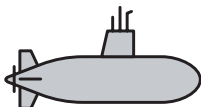

23.



24.



25.



26.



27.



# Picture Dictionary cont.



28.



29.



30.

---

---

---

---

---

---

# Assessment

Student / Group: \_\_\_\_\_

Date	CLB Level	Type of Assessment	Theme	Skill Competencies
		<input type="checkbox"/> Skill-Using Activity <input type="checkbox"/> Assessment Task	Transportation	<input type="checkbox"/> Interacting with Others <input type="checkbox"/> Sharing Information <input type="checkbox"/> Getting Things Done



Criteria	Achieved 	Achieved with Help 	Needs Improvement 
identifies different types of vehicles and modes of transportation			
uses the simple present and present progressive tense correctly			
uses a variety of sentence patterns to write and talk about transportation			
explains how long it takes to get somewhere by a certain mode of transportation			
describes a preferred mode of transportation			

# Self-Assessment

## TRANSPORTATION

Add check marks (✓) to show what you've learned in this lesson.

Name: \_\_\_\_\_ Date: \_\_\_\_\_

Can I...	Yes (very well) 	Yes (with help) 	Not yet 
say and write different types of vehicles/ modes of transportation?			
use <i>take</i> , <i>ride</i> , and <i>go</i> to describe modes of transportation?			
say how long it takes to get somewhere?			
ask questions about transportation?			
answer questions about transportation?			

**My Notes**

---



---



---



---



---